

Quik Bridge™ Loop Receiver

Document Number: 466-1127 Rev. C
June 1997

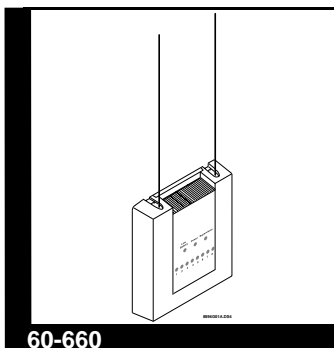

INSTALLATION INSTRUCTIONS

Product Summary

The Quik Bridge Loop Receiver (receiver) allows you to use up to 16 Learn Mode wireless sensors (two per zone) with any standard hardwire control panel. In addition, you can use up to 45 Keychain Touchpads and panic button transmitters, for a total of 61 wireless transmitters.

The receiver monitors the alarm, battery, and supervisory status of transmitters learned into the receiver's eight zones.

The receiver features the following:

- Spatial-diversity receiver, which enhances reception
- 8 zone outputs which can be N/C or N/O (programmable)
- Selectable zone supervision (programmable)
- Cover tamper, which initiates an alarm on zone 8 (optional)
- 8 zone LEDs, which indicate zone openings and closings
- 2 trouble LEDs, which indicate zone trouble conditions.
- Support for a piezo (used for RF testing only) which, when used sounds the number of transmissions received from learned transmitters.
- Compatibility with X-10® Modules
- On-board EEPROM which stores sensor IDs and programming information in non-volatile memory, even after power is removed.

Transmitter Compatibility

- All current ITI Learn Mode™ sensors, panic button transmitters, 2- and 4-button Keychain Touchpads.
- Quik Bridge Learn Mode Repeater (60-615).

Control Panel Compatibility

The receiver is compatible with control panels designed with hardwire loops where the loop negative is ground, otherwise known as a common-loop ground.

The loop receiver is **not** directly compatible with powered loops (2-wire smoke detector loops and glass break detector loops). If the loop on the control panel can power a device, it must not be connected directly to the loop receiver. Instead, a relay is required when connecting to powered loops.

The following control panels (one or more versions) support a common-loop ground for one or more of its loops. If your control panel is not listed below, you can test it for compatibility (see "Compatibility Testing" section below).

- ADT SafeWatch®
- Ademco® 4110XM, Vista 10, Via 30P
- C&K® System 236
- DSC® PC1550, DSC Power 832 PC5010
- First Alert® FA 1330C
- Moose® Z1100e
- Napco® Magnum Alert 1008e/M
- Radionics® D9112B

Compatibility Testing

Typically, hardwire loops have the negative (-) side of the loop common with ground. If this is true and the loop is non-powered, the loop should be compatible with the receiver.

Although most control panels are compatible with the receiver's open collector outputs, each loop should be tested for compatibility before connecting receiver outputs to the control panel loop inputs. If the receiver is not directly compatible with a control panel loop, a relay can be used to establish compatibility.

To check if the negative side of the loop is common to control panel ground, perform the following test:

1. Turn off or remove control panel power and disconnect the back-up battery.
2. Use an ohm meter and measure the resistance between the negative side of the loop and panel ground. If the resistance is zero or close to zero, this loop should be compatible with the loop receiver. If the resistance is not zero, a relay is required for this loop.

Perform this compatibility test for all loops that are to be connected to the receiver.

Overview of Receiver Operation

DIP Switch

There is a single DIP switch on the receiver board (see Figure 1) which controls the mode of operation. When the DIP switch is up, the receiver is in program mode. When the DIP switch is down, the receiver is in run mode.

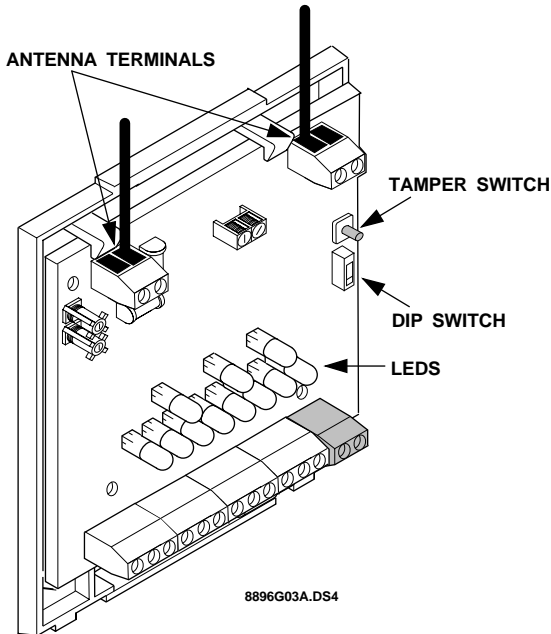

Figure 1. Important Parts of the Receiver

Tamper Switch Function

Tamper Switch Function while in Run Mode

When no transmitters have been learned into zone 8, the receiver's tamper switch is active. Tripping the tamper switch (by removing the cover) causes an alarm on zone 8.

If one or more transmitters are learned into zone 8, the tamper switch is inactive and does not cause an alarm.

Tamper Switch Function while in Program Mode

While in program mode, pressing the tamper switch cycles through 3 programming areas:

- Learning and Deleting Transmitters
- Configuring Zone/Trouble Outputs N/O or N/C

- Enabling/Disabling Zone Supervision

Outputs

The receiver uses open-collector transistors for the zone and trouble outputs (see Figure 2). The outputs can be open (high impedance) or closed (shorted to ground), which can be configured to be normally closed (N/C) or normally open (N/O). Each output can be wired to the control panel.

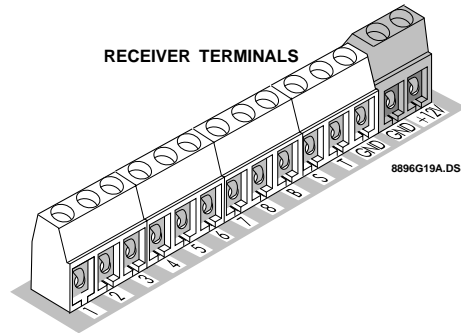

Figure 2. Receiver Terminal Strip

Zone Outputs

There are eight zone outputs labeled 1 through 8. If a learned transmitter is activated, the corresponding zone output switches to the alarm state. The zone output remains in alarm for at least 3 seconds and until the transmitter is restored to its non-alarm state. (If the control panel connected to the receiver is armed, the panel activates an alarm in response to the zone output transition.)

Trouble Outputs

There are two trouble outputs labeled **B** (low battery summary) and **S** (supervisory failure summary).

- B** - Low Battery: When a learned transmitter sends a low battery signal, this output switches to, and remains in the alarm state until the receiver receives a signal from the same transmitter with a good battery.
- S** - Supervisory: If a learned supervised transmitter fails to report for four hours, this output switches to the alarm state until the failed or unreporting transmitters have reported to the receiver.

Test Output

- T** - Test/Piezo: This output momentarily supplies 5 VDC each time a transmitter sends an alarm signal to the receiver. Connect a piezo (optional) to this output only when testing RF transmitter response.

LED Indicators

The receiver has 11 LEDs: 8 red zone LEDs (bottom row), a green Power LED, a red Low Battery LED, and a red Supervisory LED (see Figure 3).

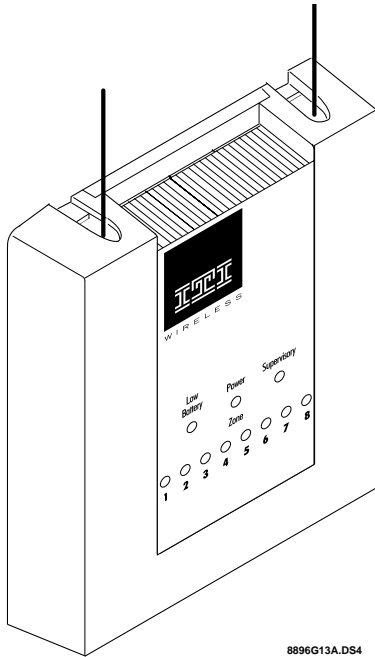

Figure 3. Receiver LEDs

In run mode, the LEDs indicate alarm and trouble conditions. In program mode, the LEDs indicate programming conditions.

Power LED/Self-Tests

The power LED turns on after power is applied to the receiver and the self-tests are passed. It will blink once each time a signal is received from a Learn Mode™ transmitter. If the receiver fails the self-tests, the power LED does not turn on. Instead, the trouble LEDs flash alternately for a failed self-test.

Table 1. Power LED

Power LED	Indicates
On steady	receiver has power and is functioning normally.
All LEDs off	receiver is not properly wired or has a power failure.
Off & other top 2 red LEDs blinking	receiver failed power-up test.

Table 1. Power LED

Power LED	Indicates
Blinks off momentarily	receiver received an RF signal, whether learned or not.

Run Mode LED Indications

In run mode, the LEDs indicate 3 conditions: alarm, low battery, and supervisory failure.

To diagnose alarm status conditions:

When the trouble LEDs are both off, the zone LEDs indicate alarm information.

The zone LEDs turn on for zones that are open (in alarm). Zone LEDs remain off for zones that are closed or not used.

To diagnose transmitter low battery conditions:

The red low battery LED indicates when one or more transmitters have reported a low battery condition. After a low battery report, the low battery LED flashes or blinks once every three seconds, in sync with at least one zone LED. Check the corresponding zone's transmitter(s) for low battery conditions.

To diagnose transmitter supervisory conditions:

The red supervisory LED indicates when one or more transmitters have failed to report to the receiver for at least 4 hours. When a supervisory condition exists, the supervisory LED flashes or blinks every three seconds, in sync with at least one zone LED. Check the corresponding zone's transmitter(s) for supervisory conditions.

Figure 4 shows the alarm, low battery and supervisory run mode LED indications.

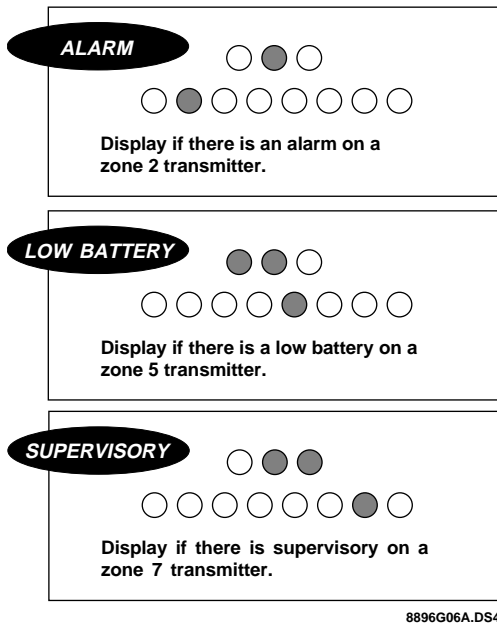

Figure 4. Run Mode LED Indications

Tools and Accessories Needed

Included with Receiver

- Mounting screws and anchors
- Spring for tamper switch
- 2 antennas

Not Included with Receiver

- Phillips screwdriver
- Small standard screwdriver
- 12-22 gauge stranded wire
- Optional piezo status beeper for testing (30-006)
- 12 VDC power supply (typically supplied by panel)
- EOL Resistors (typically supplied with panel)

Installation Guidelines

Observe the following guidelines when installing the receiver:

- Leave 10" above the receiver for the antennas.
- Avoid areas that are likely to expose the receiver to

moisture.

- Avoid areas with excessive metal or electrical wiring, including furnace and utility rooms.
- or-- If unavoidable, mount on metal with the antennas extending above the metallic surface (see Figure 5).

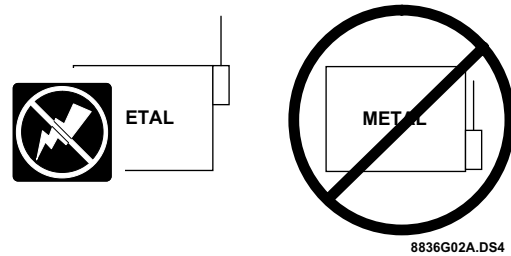

Figure 5. When Mounting on Metal is Unavoidable

Installing the Receiver

Mounting the Receiver

CAUTION: You must be free of static electricity before handling circuit boards. Touch a bare metal surface or wear a grounding strap to discharge yourself.

- 1) Remove the receiver's cover by pressing down on the top center of the cover (see Figure 6.).

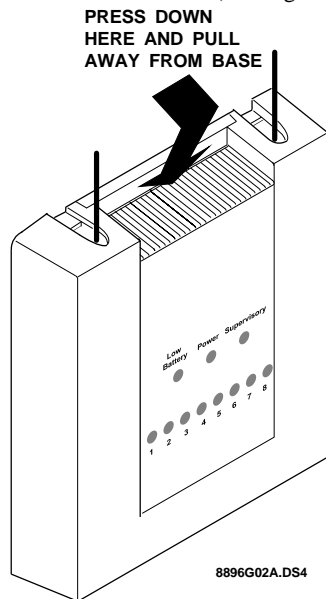

Figure 6. Removing the Receiver's Cover

- 2) Press down on the lower right corner of the base until the lower right latch releases the circuit board (see Figure 7).
- 3) Remove the circuit board by pulling it away from the top two latches. Set the circuit board in the receiver cover.
- 4) Hold the base against the mounting surface and mark the three mounting holes (see Figure 7). Leave at least 10" above the base for the antennas.

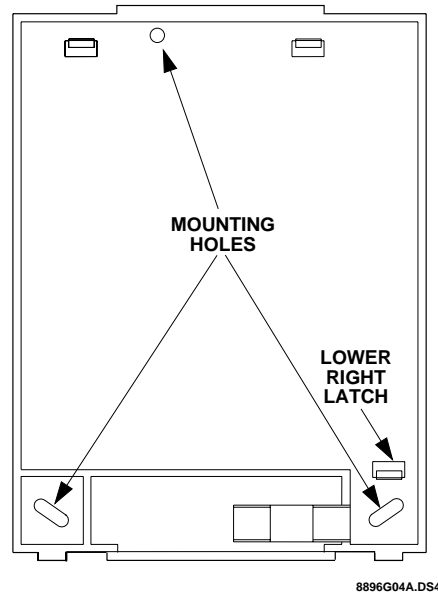

Figure 7. Base Mounting Hole Locations

- 5) Remove the base and install the anchors provided, if studs are not present.
- 6) Place the base on the wall and secure it using the screws provided.
- 7) Replace the circuit board on the base by first sliding the top of the circuit board under the top two latches, then gently press on the bottom of the circuit board until it snaps under the lower right latch.

Connecting the Antennas to the Receiver

To connect antennas to the receiver:

- 1) Loosen the **inside** terminals of the left and right antenna terminal blocks.
- 2) Insert an antenna into each **inside** terminal.
- 3) Tighten the terminal screws.

Powering

To connect power to the receiver:

1. Turn off or remove power from the panel and disconnect the battery.
2. Wire receiver terminals (GND) and (+12V) to a non-switched 12V supply output on the control panel. Make sure you observe the correct polarity (see Figure 8).

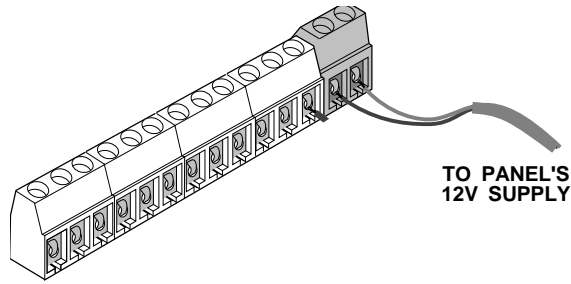

Figure 8. Connecting Panel Power to the Receiver

3. Turn on or apply power to the panel.

Zone Planning

Before programming, it's a good idea to write down how you plan to use the transmitters and panic buttons with each zone.

The following guidelines describe the receiver zone capabilities. Use these guidelines to help you complete Table 2 for recording the wireless devices used for each zone.

Zone Planning Guidelines

Keychain Touchpads

The receiver can learn up to 45 Keychain Touchpads. The following describes the Keychain Touchpad button functions.

Suggested applications include panic button, momentary or maintained (toggle on/off) control panel activation for arming/disarming, or momentary activation for a garage door opener. Maintained output applications also include X-10 light control (see "X-10 Applications").

Note: All Keychain Touchpads learned into the receiver control the same zone outputs. For example, if Keychain Touchpad #1 is learned into zone 1 and Keychain Touchpad #2 is learned into zone 2, both Keychain Touchpads control both zones.

- **Zone 1: Lock & Unlock Buttons Together**—This simultaneous keypress can be learned only into zone 1 and still allows you to learn 2 additional sensors into zone 1. When learned, this keypress causes a momentary alarm on zone 1.

Note: Both panic button transmitters and this keypress can be learned into zone 1 together; however, the total number of panic buttons and Keychain

Touchpads learned into zone 1 cannot exceed 45.

Note: For zones 2 through 6, keychain touchpads and other sensors can not be learned into the same zone.

- **Zone 2: Lock or Unlock Button**—When learned into zone 2, both of these keypresses work together to provide a maintained (toggle) output response (only one of these buttons needs to be learned for both to work).

Typically, this output would be used for a maintained keyswitch on the control panel for arming/disarming (refer to the control panel instructions for this application).

When learned, pressing the lock button arms the system and pressing the unlock button disarms the system.

- **Zone 3: Lights Button**—This keypress can be learned only into zone 3. When learned, pressing this button switches the zone 3 output. The output can be configured to switch momentarily (default) or maintained (toggle on/off for each press) (See Configuring Touchpad Zone Output Responses).
- **Zone 4: Star Button**—This keypress can be learned only into zone 4. When learned, pressing this button switches the zone 4 output. The output can be configured to switch momentarily (default) or maintained (toggle) (See Configuring Touchpad Zone Output Responses).
- **Zone 5: Lock Button**—This keypress can be learned into zone 2 (as detailed above) or zone 5. When learned into zone 5, pressing this button switches the zone 5 output. The output can be configured to switch momentarily (default) or maintained (toggle) (See Configuring Touchpad Zone Output Responses).
- **Zone 6: Unlock Button**—This keypress can be learned into zone 2 (as above) or zone 6. When learned into zone 6, pressing this button switches the zone 6 output. The output can be configured to switch momentarily (default) or maintained (toggle) (See Configuring Touchpad Zone Output Responses).

Tamper and Trouble Conditions

- **Receiver Tamper Switch**—Zone 8 is set up to automatically monitor the receiver's tamper switch. However, once a transmitter is learned into zone 8, tamper switch activation is ignored by the receiver.
- **Low Battery**—Receiver terminal B activates whenever the receiver gets a signal from a transmitter with a low battery. To monitor for low transmitter battery conditions, connect the receiver's B output

to a control panel zone input.

- **RF Supervision**—Receiver terminal S activates whenever the receiver goes four hours without receiving a signal from a supervised transmitter. To monitor for RF supervision, connect the receiver’s S output to a control panel zone input.

Panic Buttons and Wireless Sensors

- **Panic Buttons**—Use zone 1 for up to 45 unsupervised panic button transmitters. Use zones 2 - 8 for supervised panic button transmitters (2 per zone).

Wireless Sensors—Learn wireless sensors into remaining unused zones (2 per zone). Make sure that both sensors learned into the same zone have the same expected response type at the control panel (i.e. delay, instant, interior, 24-hour).

Table 2. Transmitter Zone Assignments

Recvr. Zone	Panel Zone	Transmitter	Function
8		_____	_____
B			
S			

Table 2. Transmitter Zone Assignments

Recvr. Zone	Panel Zone	Transmitter	Function
1		_____	_____
2		_____	_____
3		_____	_____
4		_____	_____
5		_____	_____
6		_____	_____
7		_____	_____

Programming the Receiver

To set the receiver in program mode, slide the DIP switch up. The low battery and supervisory LEDs flash alternately, indicating the receiver is ready to *Learn/Delete Transmitters*.

Press and release the tamper switch once and the low battery LED turns on solid or flashes, indicating the receiver is ready to *Configure Zone/Trouble Outputs N/O or N/C*.

Press and release the tamper switch once more and the supervisory LED turns on solid, indicating the receiver is ready to *Enable/Disable Transmitter Supervision*.

Learning Wireless Transmitters

To learn a transmitter into a zone:

- 1) Install a grounding wire to the receiver’s GND terminal (see Figure 9).

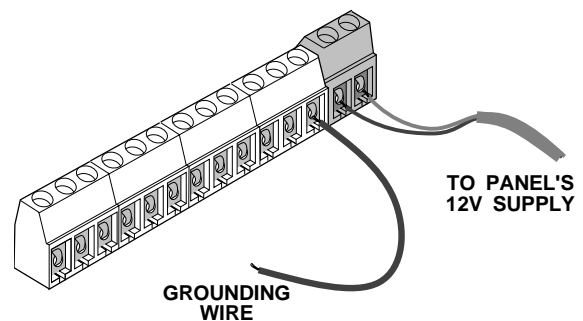

Figure 9. Installing a Grounding Wire On the Receiver

- 2) Set the receiver for Learn/Delete Transmitters.
- 3) Select a zone to learn the transmitter into by momentarily grounding the zone output with the grounding wire. The selected zone’s LED lights and all other LEDs turn off.
- 4) Wait for the zone LED to stop flashing (about 5 seconds).

- 5) Trip the transmitter(s):
For sensors with tamper switches, activate the sensor's tamper switch by removing the cover.
For sensors without tamper switches, put the sensor in alarm.
 Each time the receiver learns a sensor, the selected zone LED blinks once.
For Keychain Touchpads:
 Zone 1, press the lock and unlock buttons together.
 Zone 2, press the lock button.
 Zone 3, press the lights button.
 Zone 4, press the star button.
 Zone 5, press the lock button.
 Zone 6, press the unlock button.
 Each time the receiver learns a Keychain Touchpad button, all zone LEDs with learned Keychain Touchpads blink once.
- 6) To stop learning transmitters in the selected zone, slide the DIP switch down.
- 7) Repeat steps 2 - 6 to learn transmitters into another zone.

Deleting Wireless Transmitters

To delete all transmitters from a zone:

- 1) Install a grounding wire to the receiver's GND terminal (see Figure 9).
- 2) Set the receiver for Learn/Delete Transmitters.
- 3) Select the zone to delete the transmitter from by momentarily grounding the zone output with the grounding wire. The selected zone's LED lights and all other LEDs turn off.
- 4) While the selected zone LED is blinking, momentarily ground the zone output again. This deletes all transmitters in the selected zone.
- 5) To delete all transmitters from another zone, repeat steps 3 and 4.
- 6) Slide the dip switch down to put the receiver in run mode.

To delete a Keychain Touchpad from the receiver:

To delete a Keychain Touchpad from the receiver, each zone that has buttons learned into the receiver must be deleted.

Configuring Zone/Trouble Outputs N/O or N/C

All 8 zones and both trouble outputs default to N/C, and can be changed to N/O.

To program a zone output N/O or N/C:

- 1) Install a grounding wire to the receiver's GND terminal (see Figure 9).

- 2) Slide the DIP switch up and press the tamper switch once. The low battery LED turns on solid or flashes, indicating the receiver is ready to configure zone/trouble outputs.
- 3) Select the zone to change configuration by momentarily grounding the zone output with the grounding wire. The selected zone's LED turns off (N/O) or turns on (N/C).
- 4) Repeat step 3 to change another zone's configuration.
- 5) Slide the DIP switch down to return to run mode.

To program both trouble outputs N/O or N/C:

- 1) Install a grounding wire to the receiver's GND terminal (see Figure 9).
- 2) Slide the DIP switch up and press the tamper switch once. The low battery LED turns on solid or flashes, indicating the receiver is ready to configure zone/trouble outputs.
- 3) Change the trouble output configuration by momentarily grounding terminal **B**. The low battery LED turns on steady (N/C) or flashes (N/O), indicating the new configuration.
- 4) Slide the DIP switch down to return to run mode.

Configuring RF Supervision

All 8 zones default to be RF supervised, and can be changed to be unsupervised.

To enable or disable RF supervision on a zone:

- 1) Install a grounding wire to the receiver's GND terminal (see Figure 9).
- 2) While in program mode, advance through the programmable options by pressing the tamper switch until the supervisory LED lights.
- 3) Select a zone to enable or disable supervisory monitoring by momentarily grounding the zone output. The selected zone's LED turns off (unsupervised) or on (supervised), indicating the new configuration.
- 4) Repeat step 3 to enable or disable another zone's supervisory monitoring.
- 5) Advance to another programmable option or exit program mode by sliding the DIP switch down.

Note: Keychain Touchpads are not supervised. Panic Button transmitters learned into zone 1 are not supervised.

Configuring Keychain Touchpad Zone Output Responses

Zone 3 through 6 outputs can be set up to respond by switching momentarily or to maintain (toggle on/off for each activation).

To change the zone output response to momentary or maintained:

- 1) Install a grounding wire to the receiver's GND terminal (see Figure 9).
- 2) While in program mode, advance through the programmable options by pressing the tamper switch until the supervisory LED lights.
- 3) Select a zone (3-6) to configure by momentarily grounding the zone output. The selected zone's LED turns off (maintained) or on (momentary), indicating the new configuration.
- 4) Repeat step 3 to configure another zone's output switching.
- 5) Advance to another programmable option or exit program mode by sliding the DIP switch down.

X-10 Applications

There are two ways to use X-10 devices:

- Light Control—using an X-10 Powerflash Interface Module (13-058) and X-10 Lamp Modules (13-204), the lights button on a 4-Button Keychain Touchpad can be used to control lights.
- Garage Door Opener Control—using an X-10 Powerflash Interface Module (13-058) and an X-10 Universal Module (13-399), the star button on a 4-Button Keychain Touchpad can be used to control a garage door opener. You can also use an optional relay connected to zone 4.

Light Control

To set up light control:

- 1) Learn the lights button of a 4-Button Keychain Touchpad into zone 3.
- 2) Configure zone 3 for N/O if you want the zone 3 LED to turn on when lights are on,
or-- configure zone 3 for N/C if you want the zone 3 LED to turn on when lights are off.
- 3) Configure zone 3 output as maintained (see Configuring Keychain Touchpad Zone Output Responses).
- 4) Set the unit code and house code dials on the Powerflash Interface Module to match those on the Lamp Module(s).
- 5) Set the Powerflash Interface Module input switch to **B** and the mode switch to **3**.
- 6) Connect receiver terminal 3 to the Powerflash Interface Module's positive (+) terminal.
- 7) Connect the receiver GND terminal to the Powerflash Interface Module's negative (-) terminal.
- 8) Plug in the Powerflash Interface Module and all Lamp Modules.

Garage Door Opener Control

To set up garage door opener control:

- 1) Learn the star button of a 4-Button Keychain Touchpad into zone 4.
- 2) Configure zone 4 for N/O.
- 3) Set the unit code and house code dials on the Powerflash Interface Module to match those on the Universal Module.
- 4) Set the Powerflash Interface Module input switch to **B** and the mode switch to **3**.
- 5) On the Universal Module, set the lower-left switch to **momentary** and the lower-right switch to **relay only**.
- 6) Connect receiver terminal 4 to the Powerflash Interface Module's positive (+) terminal.
- 7) Connect the receiver GND terminal to the Powerflash Interface Module's negative (-) terminal.
- 8) Plug in the Powerflash Interface Module and Universal Module.
- 9) Connect the garage door opener wires to the N/O relay connection on the Universal Module.

Connecting the Receiver to a Control Panel

There are four ways to wire the loop receiver to the control panel. Refer to Figures 10 through 13 for panel connections.

CAUTION: All receiver programming must be completed before connecting outputs to the control panel. Panel connections can interfere with the programming procedure.

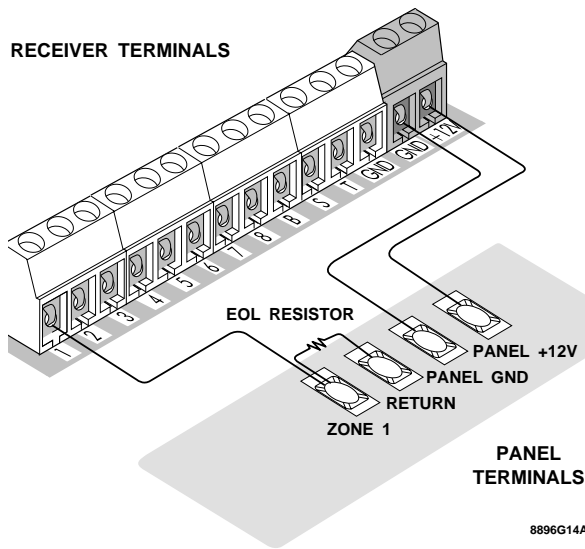

Figure 10. Wiring Diagram for a Supervised N/O Loop

Note: You can connect multiple normally open loop receiver zone outputs in parallel to panel zone inputs.

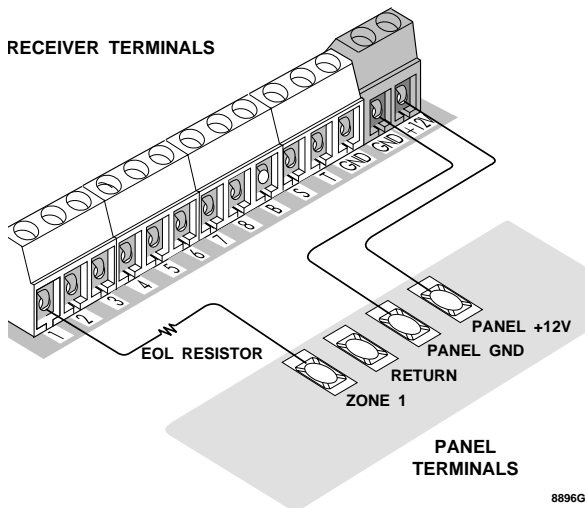

Figure 11. Wiring Diagram for a N/C Loop

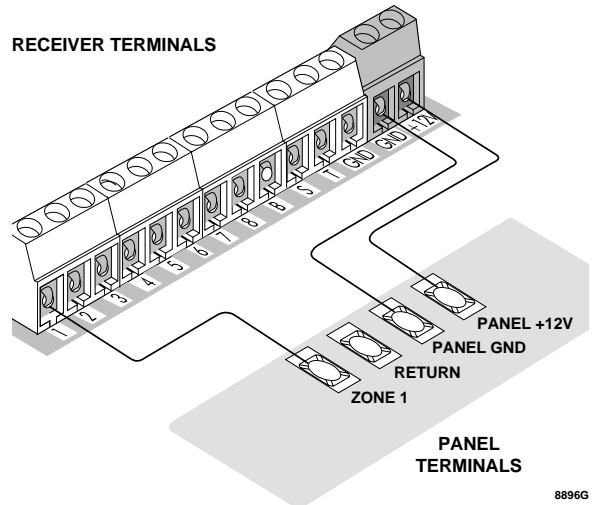

Figure 12. Wiring Diagram for a Nonsupervised Loop

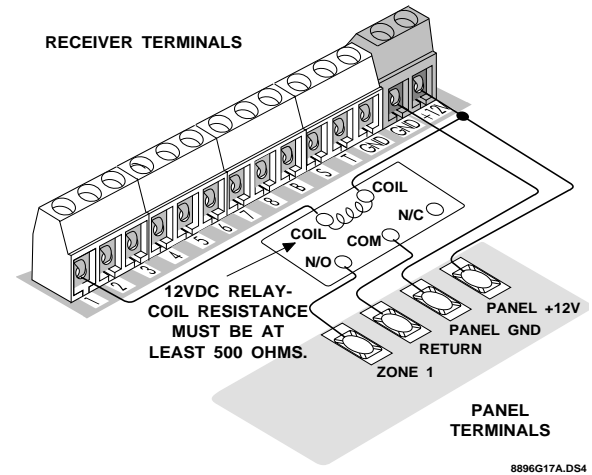

Figure 13. Wiring Diagram when using a Relay

Testing RF Reception

You can test the receiver two ways: (1) counting the LED flashes when transmitters are tripped or (2) counting the beeps emitted by an attached piezo beeper (optional).

To test the system using the receiver's LED:

- 1) Make sure the DIP switch is down (normal operation/run mode).
- 2) Trip all sensors in the system.
- 3) After each trip, watch for the correct number of LED flashes (see Table 3).

To test the system using a piezo beeper:

- 1) Connect a piezo (30-006) beeper between the test output (T) and ground (GND) (see Figure 14).

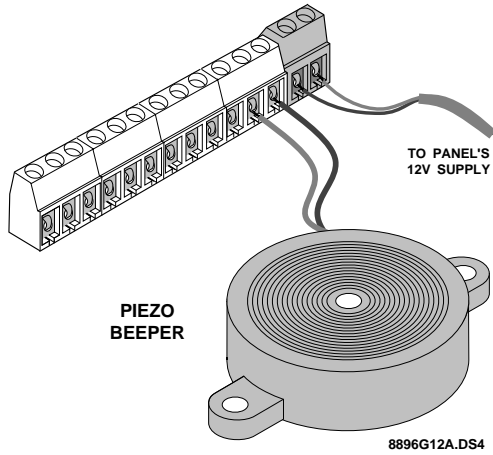

Figure 14. Piezo Status Beeper Connections

- 2) Make sure the dip switch is down (normal operation/run mode).
- 3) Trip all sensors in the system.
- 4) After each trip, listen for the correct number of beeps from the piezo beeper (see Table 3).

Table 3. LED/Piezo Test Responses

Transmitter		Should Cause
Sensors		7–8 beeps and LED flashes
Keychain Touch-pads	1-Button Press	2 beeps and LED flashes
	2-Button Press	8 beeps and LED flashes

Specifications

Compatibility: Control panels with hardwire loops.

Power Requirements: 10.0 – 14.0 VDC

Current Draw: 75 mA maximum (excluding external relays)

Operating Temperature Range: 40° to 120°F

Dimensions: 4.125" x 5.25" x 1" (L x W x H), excluding antennas.

FCC Notices

This equipment has been tested and found to comply with the limits for a class B digital device, pursuant to part 15 of the FCC rules. These limits are designed to provide reasonable protection against harmful interference in a residential installation. This equipment generates, uses, and can radiate radio frequency energy and, if not installed and used in accordance with the instructions, may cause harmful interference to radio communications. However, there is no guarantee that interference will not occur in a particular installation. If this equipment does cause harmful interference to radio or television reception, which can be determined by turning the equipment off and on, the user is encouraged to try to correct the interference by one or more of the following measures:

- Install a quality radio or television outdoor antenna if the indoor antenna is not adequate.
- Reorient or relocate the panel.
- Move the panel away from the affected equipment.
- Move the panel away from any wire runs to the affected equipment.
- Connect the affected equipment and the panel to separate outlets, on different branch circuits.
- Consult the dealer or an experienced radio/TV technician for help.

Send for the FCC booklet *How to Identify and Resolve Radio-TV Interference Problems*, available from the U.S. Government Printing Office, Washington, D.C. 20402.

Stock Number: 004-000-00345-4.

This device complies with FCC Rules Part 15. Operation is subject to the following two conditions:

This device may not cause harmful interference.

This device must accept any interference that may be received, including interference that may cause undesired operation.

Changes or modifications not expressly approved by Interactive Technologies, Inc. can void the user's authority to operate the equipment.



INTERACTIVE TECHNOLOGIES, INC.

2266 SECOND STREET NORTH

NORTH SAINT PAUL, MN 55109

T: 612/777-2690

F: 612/779-4890

W I R E L E S S

Security

Automation

Access Control

ITI is a registered trademark of Interactive Technologies, Inc. Quik Bridge and Learn Mode are trademarks of Interactive Technologies, Inc. X-10 is a registered trademark of X-10 (USA), Inc. All other manufacturer and product names are trademarks and/or registered trademarks of their respective names.